

# SONY®

## Sound Bar

Operating Instructions

A close-up photograph of the Sony Sound Bar, showing the top surface with the Sony logo embossed in the center. The bar has a dark, textured finish and rounded corners. The bottom edge shows a fine, woven mesh grille.

SONY

HT-S100F/SF150

## WARNING

Do not install the appliance in a confined space, such as a bookcase or built-in cabinet.

To reduce the risk of fire, do not cover the ventilation opening of the appliance with newspapers, tablecloths, curtains, etc.

Do not expose the appliance to naked flame sources (for example, lighted candles).

To reduce the risk of fire or electric shock, do not expose this appliance to dripping or splashing, and do not place objects filled with liquids, such as vases, on the appliance.

The unit is not disconnected from the mains as long as it is connected to the AC outlet, even if the unit itself has been turned off.

As the main plug is used to disconnect the unit from the mains, connect the unit to an easily accessible AC outlet. Should you notice an abnormality in the unit, disconnect the main plug from the AC outlet immediately.

## CAUTION

Risk of explosion if the battery is replaced by an incorrect type. Do not expose batteries or appliances with battery-installed to excessive heat, such as sunshine and fire.

Indoor use only.

## Recommended cables

Properly shielded and grounded cables and connectors must be used for connection to host computers and/or peripherals.

## For the Bar Speaker

The nameplate is located on the bottom of the Bar Speaker.

## For the customers in Europe

### **Notice for customers: the following information is only applicable to equipment sold in countries applying EU directives and/or UK applying relevant statutory requirements**

This product has been manufactured by or on behalf of Sony Corporation.

EU and UK Importer: Sony Europe B.V.

Inquiries to the EU Importer or related to product compliance in Europe should be sent to the manufacturer's authorized representative, Sony Belgium, *bijkantoor van Sony Europe B.V.*, Da Vincilaan 7-D1, 1930 Zaventem, Belgium.

Inquiries to the UK Importer or related to product compliance in the UK should be sent to the manufacturer's authorized representative, Sony Europe B.V., The Heights, Brooklands, Weybridge, Surrey KT13 0XW, United Kingdom.



Hereby, Sony Corporation declares that this equipment is in compliance with Directive 2014/53/EU. The full text of the EU declaration of conformity is available at the following internet address: <https://compliance.sony.eu>

Hereby, Sony Corporation declares that this equipment is in compliance with the UK relevant statutory requirements. The full text of the declaration of conformity is available at the following internet address:

<https://compliance.sony.co.uk>

This equipment has been tested and found to comply with the limits set out in the EMC regulation using a connection cable shorter than 3 meters.



**Disposal of waste batteries and electrical and electronic equipment (applicable in the European Union**

**and other countries with separate collection systems)**

This symbol on the product, the battery or on the packaging indicates that the product and the battery shall not be treated as household waste. On certain batteries this symbol might be used in combination with a chemical symbol. The chemical symbol for lead (Pb) is added if the battery contains more than 0.004% lead. By ensuring that these products and batteries are disposed of correctly, you will help to prevent potentially negative consequences for the environment and human health which could be caused by inappropriate waste handling. The recycling of the materials will help to conserve natural resources. In case of products that for safety, performance or data integrity reasons require a permanent connection with an incorporated battery, this battery should be replaced by qualified service staff only. To ensure that the battery and the electrical and electronic equipment will be treated properly, hand over these products at

end-of-life to the appropriate collection point for the recycling of electrical and electronic equipment. For all other batteries, please view the section on how to remove the battery from the product safely. Hand the battery over to the appropriate collection point for the recycling of waste batteries. For more detailed information about recycling of this product or battery, please contact your local Civic Office, your household waste disposal service or the shop where you purchased the product or battery.

**For the customers in Australia or New Zealand**

It should be installed and operated with at least 20 cm and more between the radiator and person's body (excluding extremities: hands, wrists, feet and ankles).

**For the customers in Australia**



**Disposal of old electrical & electronic equipment (applicable in the European Union and other countries with separate**

**collection systems)**

---

## Table of Contents

---

Basic Setup	➔ Startup Guide (separate document)
About These Operating Instructions	4
What's in the Box	5
What You Can Do with the System	6
Guide to Parts and Controls	7

### Preparing for Using the System

Mounting the Bar Speaker on a Wall	13
When the TV Remote Control does not Work	15

### Listening to the Sound

Listening to a TV and Other Devices	16
Listening to Music on a USB Device	17

### Selecting the Sound Effect

Adjusting the Sound	19
---------------------	----

### Listening to Music/Sound with the BLUETOOTH® Function

Listening to Music from a Mobile Device	21
Turning the System On by Operating the BLUETOOTH Device	23
Turning the BLUETOOTH Function Off	23

### Using the Various Functions

Using the Control for HDMI Function	24
Saving Power Consumption	25

### Troubleshooting

Troubleshooting	26
Resetting the System	30

### Additional Information

Specifications	31
Playable Types of Files (USB Input)	32
Supported Input Audio Formats (HDMI OUT (TV (ARC)) or TV IN (OPTICAL))	32
On BLUETOOTH Communication	33
Precautions	34

---

## About These Operating Instructions

- The instructions in these Operating Instructions describe the controls on the remote control.
- Some illustrations are presented as conceptual drawings, and may be different from the actual products.
- The default settings are underlined on each feature description.

# What's in the Box

- Bar Speaker (1)

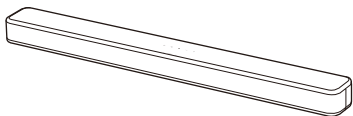

- Remote control (1)

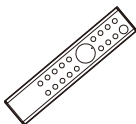

- R03 (size AAA) battery (2)



- Optical digital cable (1)

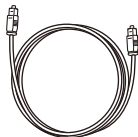

- AC power cord (mains lead) (1)
  - U.K./Ireland models



- Australia/New Zealand models



- WALL MOUNT TEMPLATE (1)



- Startup Guide



- Operating Instructions

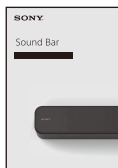

# What You Can Do with the System

**"Listening to a TV and Other Devices"  
(page 16)**



Blu-ray Disc™ player, cable box, satellite box, etc.



**Connecting the TV  
(refer to "Startup Guide" (separate document))**

**"Using the Control for HDMI Function"  
(page 24)**

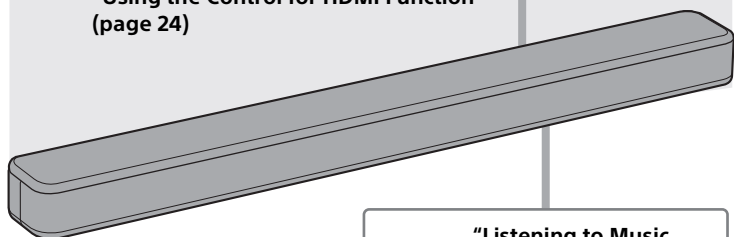

**"Listening to Music  
on a USB Device"  
(page 17)**

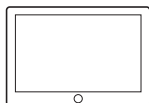
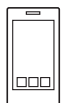

**"Listening to Music from a  
Mobile Device" (page 21)**

# Guide to Parts and Controls

Details are omitted from the illustrations.

## Bar Speaker

Front

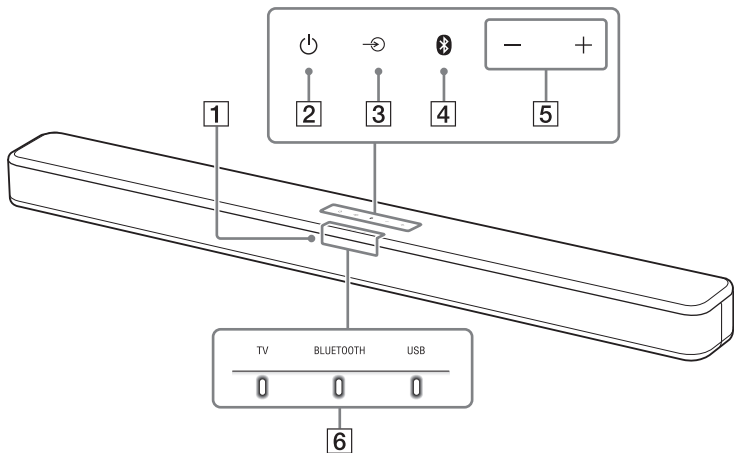

**1 Remote control sensor**

Point the remote control at the remote control sensor to operate the system.

**2  (power) button**

Turns on the system or sets it to standby mode.

**3  (input select) button (page 16)**

**4 BLUETOOTH button (page 21)**



**5 +/- (volume) buttons**

**6 Indicators**





For details, see "About the indicators on the Bar Speaker" (page 8).

## About the indicators on the Bar Speaker

Lighting and flashing of the indicator(s) on the Bar Speaker indicate the input or status of the input device.













Indicators	Status
TV 	<ul style="list-style-type: none"><li>• Lights: TV input is selected.</li></ul>
BLUETOOTH 	<ul style="list-style-type: none"><li>• Lights in blue: BLUETOOTH connection is established (BLUETOOTH input is selected).</li><li>• Flashes quickly in blue: While waiting for connection with a device.</li><li>• Flashes in blue: While reconnecting or performing pairing.</li></ul>
USB 	<ul style="list-style-type: none"><li>• Lights: USB input is selected.</li><li>• Flashes twice: The play mode is changed.</li><li>• Flashes three times first, then flashes slowly repeatedly: When connecting an unsupported device.</li><li>• Flashes repeatedly: While reading data of the connected USB device.</li></ul>

The indicators flash when turning on/off the function setting or operating the remote control.

Indicators	Status
TV 	<ul style="list-style-type: none"><li>• Flashes twice: One of the following functions is set to on.<ul style="list-style-type: none"><li>– Night mode (page 19)</li><li>– Voice mode (page 19)</li></ul></li><li>• Flashes once: The audio channel is set to Main (page 20), the sound mode is selected (page 19), or one of the following functions is set to off.<ul style="list-style-type: none"><li>– Night mode (page 19)</li><li>– Voice mode (page 19)</li></ul></li></ul>
USB 	<ul style="list-style-type: none"><li>• Flashes twice: One of the following functions is set to on.<ul style="list-style-type: none"><li>– Dolby DRC (page 20)</li><li>– Control for HDMI (page 24)</li><li>– BLUETOOTH standby (page 23)</li><li>– BLUETOOTH function (page 23)</li><li>– Auto standby (page 25)</li><li>– IR repeater (page 15)</li></ul></li><li>• Flashes once: The audio channel is set to Sub (page 20) or one of the following functions is set to off.<ul style="list-style-type: none"><li>– Dolby DRC (page 20)</li><li>– Control for HDMI (page 24)</li><li>– BLUETOOTH standby (page 23)</li><li>– BLUETOOTH function (page 23)</li><li>– Auto standby (page 25)</li><li>– IR repeater (page 15)</li></ul></li></ul>
TV    BLUETOOTH    USB 	<ul style="list-style-type: none"><li>• Flash once: The audio channel is set to Main/Sub (page 20).</li></ul>
TV    BLUETOOTH    USB 	<ul style="list-style-type: none"><li>• Flash quickly: The protection feature is activated (page 29).</li><li>• Flash slowly: The system enters standby mode by the auto standby function (page 25).</li></ul>



The indicators flash while adjusting the volume level.

Indicators			Status
TV	BLUETOOTH	USB	• Flashes once: The volume level is low.
			
TV	BLUETOOTH	USB	• Flash once: The volume level is medium.
			
TV	BLUETOOTH	USB	• Flash once: The volume level is high.
			
TV	BLUETOOTH	USB	• Flash repeatedly: The sound is muted. • Flash twice: The volume level is set to maximum/minimum.
			

### Tip

You can turn the indicators off by pressing INDICATOR.

Even if the indicators are turned off by pressing INDICATOR, if you operate the system, the indicators in relation to the operation light or flash.

## Rear

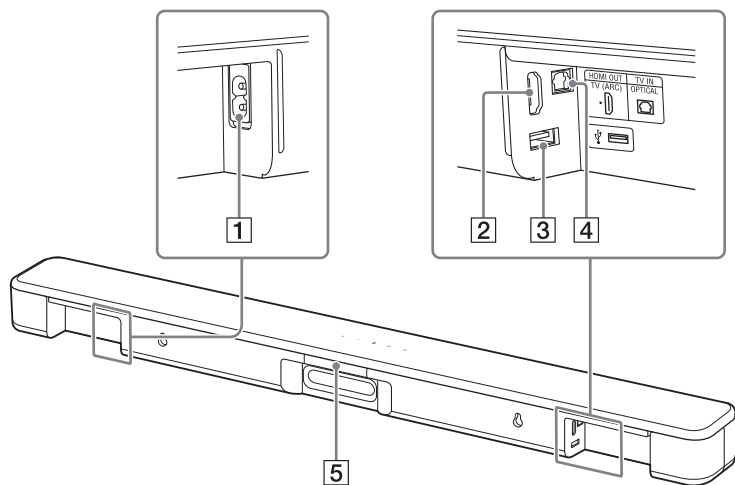

### **1** AC IN terminal

### **2** HDMI OUT (TV (ARC)) jack

Connect a TV that has an HDMI input jack with an HDMI cable. The system is compatible with Audio Return Channel (ARC). ARC is the function that sends TV sound to an AV device such as the system from the TV's HDMI jack.

### **3** USB port (page 17)

### **4** TV IN (OPTICAL) jack

### **5** IR repeater (page 15)

Transmits the remote signal of the TV remote control to the TV.

## Remote Control

Some buttons function differently depending on how long the button is pressed. The icons below indicate how long to press the button.

- : Press the button.
- (with a horizontal line through it): Press and hold the button for 5 seconds.

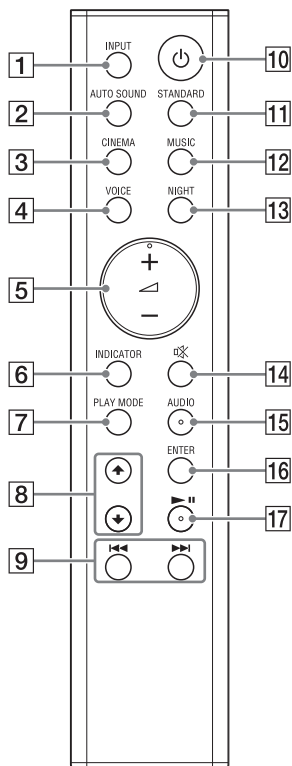

### 1 INPUT (page 16)

Selects the playback source. When you press INPUT once, the current input indicator flashes.

Press INPUT again to select the device you want.

Each time you press INPUT, the input changes cyclically as follows.  
TV input → BLUETOOTH input → USB input

### 2 AUTO SOUND (page 19)

Selects AUTO SOUND for the sound effect.

### 3 CINEMA

●: Selects CINEMA for the sound effect. (page 19)

● (with a horizontal line through it): Turns on/off the auto standby function. (page 25)

### 4 VOICE

●: Turns on/off the voice mode. (page 19)

● (with a horizontal line through it): Turns on/off the Control for HDMI function. (page 24)

### 5 ◀ (volume) +\*/-

Adjusts the volume.

### 6 INDICATOR (page 8)













Turns on/off the indicators on the Bar Speaker.



### 7 PLAY MODE (page 17)

Selects the play mode for USB playback.

### 8 ↑/↓ (page 17)

Select the content on the TV screen for USB playback.

- 9**  **(previous/next)**  
(page 17, 21)  
Pressing the button shortly goes to the beginning of the previous or next file.  
Pressing and holding searches backward or forward (rewind/fast forward).
- 10**  **(power)**  
Turns on the system or sets it to standby mode.
- 11** **STANDARD**  
: Selects STANDARD for the sound effect. (page 19)  
: Turns on/off the IR repeater function. (page 15)
- 12** **MUSIC (page 19)**  
Selects MUSIC for the sound effect.
- 13** **NIGHT**  
: Turns on/off the night mode. (page 19)  
: Turns on/off the BLUETOOTH standby mode. (page 23)
- 14**  **(muting)**  
Turns off the sound temporarily or turn on the sound.
- 15** **AUDIO\***  
: Selects the audio channel for Dolby Digital multiplex broadcast. (page 20)  
: Turns on/off the Dolby DRC function. (page 20)
- 16** **ENTER (page 17)**  
Plays the content that is selected by / for USB playback.
- 17**  **(play/pause)\* (page 17, 21)**  
Pauses or resumes playback.

\* The AUDIO, , and  buttons have a tactile dot. Use it as a guide during operation.

## Preparing for Using the System

# Mounting the Bar Speaker on a Wall

You can mount the Bar Speaker on a wall.

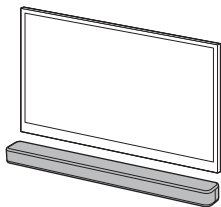

### Notes

- Prepare screws (not supplied) that are suitable for the wall material and strength. As a plasterboard wall is especially fragile, attach the screws securely in the wall beam. Install the speakers horizontally, hung by screws in studs in a continuous flat section of the wall.
- Have the installation done by a Sony dealer or licensed contractor and pay special attention to safety during the installation.
- Sony shall not be held responsible for accidents or damage caused by improper installation, insufficient wall strength, improper screw installation or natural disaster, etc.

- 1 Prepare two screws (not supplied) that are suitable for the wall mount holes on the rear of the Bar Speaker.**

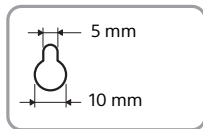
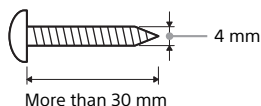

Hole on the rear of the Bar Speaker

- 2 Stick WALL MOUNT TEMPLATE (supplied) on a wall.**

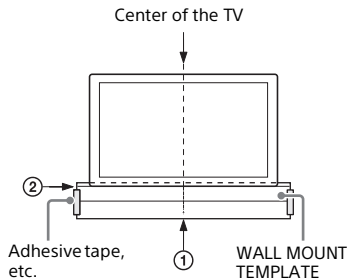

- 1 Align TV CENTER LINE (①) of WALL MOUNT TEMPLATE with the center line of your TV.**
- 2 Align TV BOTTOM LINE (②) of WALL MOUNT TEMPLATE with the bottom of your TV, then stick WALL MOUNT TEMPLATE on a wall by using a commercially available adhesive tape, etc.**

- 3** Fasten the screws into the marks on **SCREW LINE (3)** of **WALL MOUNT TEMPLATE** as the illustration below.

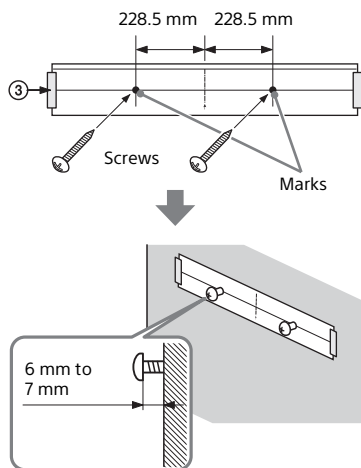

**Note**

When sticking **WALL MOUNT TEMPLATE**, smooth it out fully.

- 4** Remove **WALL MOUNT TEMPLATE**.

- 5** Hang the **Bar Speaker** on the screws.

Align the holes of the rear of the Bar Speaker with the screws, then hang the Bar Speaker on the two screws.

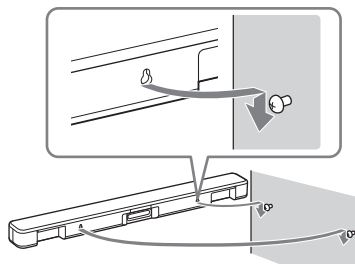

---

## When the TV Remote Control does not Work

When the Bar Speaker obstructs the remote control sensor of the TV, the TV remote control may not work. In that case, enable the IR repeater function of the system.

You can control the TV with the TV remote control by sending the remote signal from the rear of the Bar Speaker.

**Press and hold STANDARD for 5 seconds to set the function to on or off.**

---

### **IR repeater on**

The USB indicator flashes twice.

---

### **IR repeater off**

The USB indicator flashes once.

---

### **Notes**

- Be sure to check that the TV remote control cannot control the TV, and then set the IR repeater function to on. If it is set to on when the remote control can control the TV, appropriate operation may not be obtained because of the interference between the direct command from the remote control and the command via the Bar Speaker.
- On some TVs, this function may not work correctly. In this case, place the Bar Speaker slightly further away from the TV.

## Listening to the Sound

# Listening to a TV and Other Devices

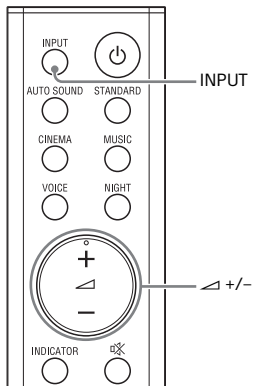

## 1 Press INPUT repeatedly.

When you press INPUT once, the current input indicator flashes. Press INPUT again to select the device you want. The indicator of the selected device lights up. Each time you press INPUT, the input changes cyclically as follows. TV input → BLUETOOTH input → USB input

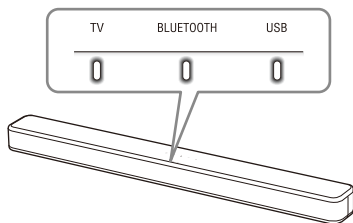

## TV input

- TV that is connected to the TV IN (OPTICAL) jack
- TV compatible with the Audio Return Channel (ARC) function that is connected to the HDMI OUT (TV (ARC)) jack

When you connect the TV to both the HDMI OUT (TV (ARC)) and TV IN (OPTICAL) jacks, the input of the HDMI OUT (TV (ARC)) jack has priority.

## BLUETOOTH input

BLUETOOTH device that supports A2DP. For details, see "Listening to Music/Sound with the BLUETOOTH® Function" (page 21).

## USB input

USB device that is connected to the  $\Psi$  (USB) port. For details, see "Listening to Music on a USB Device" (page 17).

## 2 Adjust the volume by pressing $\triangle$ +/- on the remote control.

### Tip

You can also select the input by pressing  $\rightarrow$  on the Bar Speaker.



# Listening to Music on a USB Device

You can play music files stored on a connected USB device.

For playable types of files, see “Playable Types of Files (USB Input)” (page 32).

## Notes

- To view the USB content list on the TV screen, make sure you connect the system to the TV using an HDMI cable.
- Change the input of the TV to the input which the Bar Speaker is connected.

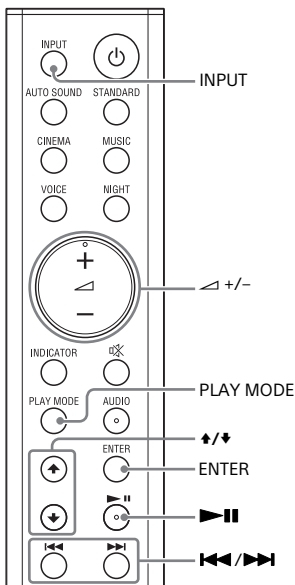

- 1 Connect the USB device to the  (USB) port.

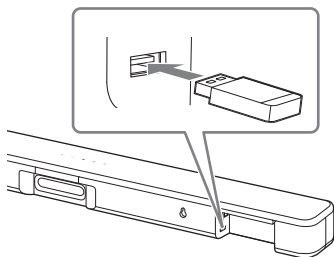

- 2 Press **INPUT** repeatedly to select the USB input.

The USB indicator lights up and the USB content list appears on the TV screen.

- 3 Press **↑/↓** to select the content you want, then press **ENTER**.

The selected content starts playing.

- 4 Press **PLAY MODE** repeatedly to select the play mode you want.

- None: Plays back all tracks.
- [Repeat One]: Repeats one track.
- [Repeat Folder]: Repeats all tracks in a folder.
- [Shuffle]: Repeats all tracks in a folder in random order.

The USB indicator flashes twice each time you press **PLAY MODE**.

- 5 Adjust the volume by pressing **▲/▼** on the remote control.

## Other operations

To	Do this
Pause or resume playback	Press ►  .
Select the previous or next track	Press ◀◀/▶▶.
Search backward or forward (rewind/fast forward)	Press and hold ◀◀/▶▶.

### Notes

- Do not remove the USB device during operation. To avoid data corruption or damage to the USB device, turn the system off before connecting or removing the USB device.
- The USB indicator flashes three times first, then flashes slowly repeatedly if you connect an unsupported USB device.
- Depending on the file format, rewind and fast forward do not work.

## Information of USB Device on the TV Screen

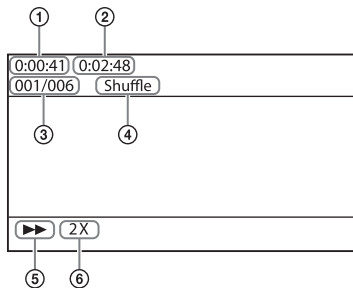

- ① Playing time
- ② Total playing time
- ③ Selected file index/Total files in the folder
- ④ Play mode
- ⑤ Playback status
- ⑥ Rewind/fast forward speed

The following messages appear on the TV screen depending on the status of the USB device.

- [No USB]  
No USB device is inserted.
- [Waiting]  
The system is searching a USB device.

### Notes

- Depending on the playback source, some information may not be displayed.
- Depending on the play mode, the information displayed may be different.

## Selecting the Sound Effect

# Adjusting the Sound

## Enjoying the Sound Effect that is Tailored to Sound Sources (Sound Mode)

You can easily enjoy pre-programmed sound effects that are tailored to different kinds of sound sources.

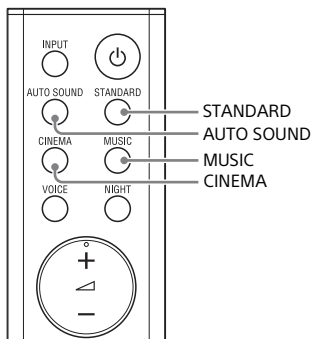

**Press AUTO SOUND, CINEMA, MUSIC, or STANDARD to select the sound mode.**

When selecting the sound mode, the TV indicator flashes once.

### **AUTO SOUND**

You can enjoy the sound with Sony-recommended sound mode. The sound mode is automatically optimized according to playback content and function.

### **CINEMA**

Sounds are played back with surround effects, and they are realistic and powerful, making them suitable for movies.

### **MUSIC**

Sound effects are optimized for listening to music.

### **STANDARD**

Sound effects are optimized for the individual source.

## Enjoying Clear Sound with Low Volume at Midnight (NIGHT)

You can compress sound in accordance with the information contained in the content by setting the night mode to on. Sound is output at low volume with minimum loss of fidelity and clarity of dialogue.

**Press NIGHT to set the function to on or off.**

### **Night mode on**

The TV indicator flashes twice.

### **Night mode off**

The TV indicator flashes once.

### **Note**

When you turn the system off, the night mode is set to off automatically.

## Making Dialogs Clearer (VOICE)

You can make dialogs clearer by setting the voice mode to on.

**Press VOICE to set the function to on or off.**

### **Voice mode on**

The TV indicator flashes twice.

### **Voice mode off**

The TV indicator flashes once.

## Making Sound with Low Volume Easy to Hear by Compressing Dynamic Range

This function works only when playing the Dolby Digital signal of the device that is connected to the TV IN (OPTICAL)/HDMI OUT (TV (ARC)) jack. When you set Dolby DRC (Dynamic Range Control) to on, dynamic range of the audio signal (range between the maximum and minimum volume) is compressed and sound with low volume is easy to hear.

**Press and hold AUDIO for 5 seconds to set the function to on or off.**

---

### Dolby DRC on

The USB indicator flashes twice.

---

### Dolby DRC off

The USB indicator flashes once.

---

## Enjoying Multiplex Broadcast Sound (AUDIO)

You can enjoy multiplex broadcast sound when the system receives a Dolby Digital multiplex broadcast signal.

**Press AUDIO repeatedly.**

The channel changes cyclically as follows.

Main → Sub → Main/Sub

---

### Main

Outputs only the main channel.  
The TV indicator flashes once.

---

### Sub

Outputs only the sub channel.  
The USB indicator flashes once.

---

### Main/Sub

Main sound is output from the left speaker and sub sound is output from the right speaker.  
The TV and USB indicators flash once.

---

### Note

To receive a Dolby Digital signal, you need to connect a TV or other devices to the TV IN (OPTICAL) jack with the optical digital cable (supplied) or the HDMI OUT (TV (ARC)) jack with an HDMI cable (not supplied).

## Listening to Music/Sound with the BLUETOOTH® Function

### Listening to Music from a Mobile Device

You can listen to music stored on a mobile device such as a smartphone or tablet via a wireless connection by connecting the system and the mobile device with the BLUETOOTH function. When connecting to the mobile device with the BLUETOOTH function, you can operate by simply using the supplied remote control without turning the TV on.

### Listening to Music by Pairing with a Mobile Device

- 1 Press and hold the **BLUETOOTH button** on the **Bar Speaker** for 5 seconds.

The system enters the pairing mode and the **BLUETOOTH indicator** flashes quickly.

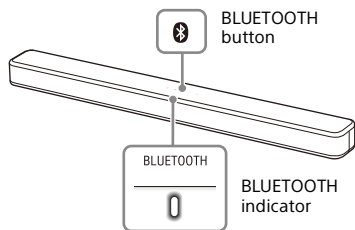

- 2 On the mobile device, turn on the **BLUETOOTH function**, and then select **"HT-S100F"** or **"HT-SF150"** after searching for it.

If a Passkey is requested, enter "0000."

- 3 Make sure that the **BLUETOOTH indicator on the Bar Speaker lights in blue**.

A connection between the system and mobile device has been established.

- 4 Start audio playback with the music app on the connected mobile device.

Sound is output from the Bar Speaker.

- 5 Adjust the volume.

- Adjust the volume by pressing  $\triangleleft$  +/- on the remote control.
- $\blacktriangleright$   $\parallel$  and  $\blacktriangleleft$  /  $\blacktriangleright$  on the remote control can be used for the BLUETOOTH function.

#### Notes

- You can pair up to 8 BLUETOOTH devices. If a 9th BLUETOOTH device is paired, the least recently connected device will be replaced by the new one.
- Perform pairing for the second and subsequent mobile devices.

#### Tips

- You can check the connection status of the BLUETOOTH function by checking the BLUETOOTH indicator status (page 8).
- While the BLUETOOTH input is being selected, the system enters the pairing mode by pressing the BLUETOOTH button on the Bar Speaker shortly.

## Listening to Music from the Paired Mobile Device

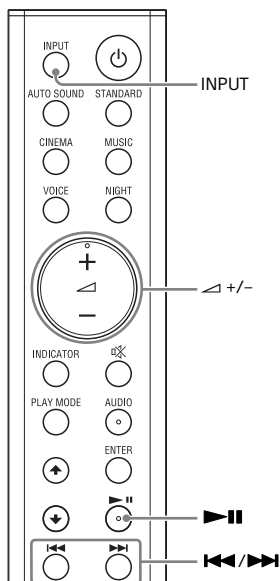

- 4 Start audio playback with the music app on the connected mobile device.

Sound is output from the Bar Speaker.

- 5 Adjust the volume.

- Adjust the volume by pressing  $\triangleleft$  +/- on the remote control.
- $\blacktriangleright||$  and  $\blacktriangleleft\blacktriangleleft/\blacktriangleright\blacktriangleright$  on the remote control can be used for the BLUETOOTH function.

- 1 Turn the BLUETOOTH function of the mobile device to on.

- 2 Press INPUT repeatedly to select the BLUETOOTH input or press the BLUETOOTH button on the Bar Speaker shortly.

The BLUETOOTH indicator flashes and the system automatically reconnects to the BLUETOOTH device it was most recently connected to.

- 3 Make sure that the BLUETOOTH indicator lights in blue.

A connection between the system and mobile device has been established.

---

## Turning the System On by Operating the BLUETOOTH Device

When the system has pairing information, you can turn the system on and listen to music from a BLUETOOTH device even when the system is in standby mode by setting the BLUETOOTH standby mode to on.

**Press and hold NIGHT for 5 seconds to set the function to on or off.**

---

### **BLUETOOTH standby mode on**

The USB indicator flashes twice.

---

### **BLUETOOTH standby mode off**

The USB indicator flashes once.

---



#### **Note**

While the BLUETOOTH standby mode is on, standby power consumption increases.

---

## Turning the BLUETOOTH Function Off

You can turn the BLUETOOTH function off.

**Press and hold , , and - on the Bar Speaker for 10 seconds to set the function to on or off.**

---

### **BLUETOOTH function on**

The USB indicator flashes twice.

---

### **BLUETOOTH function off**

The USB indicator flashes once.

---

#### **Note**

When the BLUETOOTH function is set to off, the BLUETOOTH input is skipped while selecting input by pressing INPUT.

## Using the Various Functions

### Using the Control for HDMI Function

Connecting a device such as a TV or Blu-ray Disc player compatible with the Control for HDMI function\* using an HDMI cable (not supplied) enables you to easily operate the device by using a TV or Blu-ray Disc player remote control. The following functions can be used with the Control for HDMI function.

- System Power Off function
- System Audio Control function
- Audio Return Channel
- One-Touch Play function

#### Note

These functions may work with devices other than those manufactured by Sony, but operation is not guaranteed.

\* Control for HDMI is a standard used by CEC (Consumer Electronics Control) for allowing HDMI (High-Definition Multimedia Interface) devices to control each other.

### Preparing to Use the Control for HDMI Function

**Press and hold VOICE for 5 seconds to set the function to on or off.**

---

#### Control for HDMI function on

The USB indicator flashes twice.

---

#### Control for HDMI function off

The USB indicator flashes once.

---

Enable the Control for HDMI function settings for the TV and other device connected to the TV.

### System Power Off Function

When you turn off the TV, the system will turn off automatically.

### System Audio Control Function

If you turn on the system while you are watching the TV, the TV sound will be output from the speakers of the system. The volume of the system can be adjusted using the TV remote control. If the TV sound was output from the speakers of the system the previous time you watched the TV, the system will be turned on automatically when you turn on the TV again. Operations can also be made by the TV's menu. For details, refer to the operating instructions of your TV.

#### Notes

- Sound is only output from the TV if an input other than the TV input is selected when using the Twin Picture function on the TV. When you disable the Twin Picture function, the sound is output from the system.
- The number for the system's volume level is displayed on the TV screen depending on the TV.
- Depending on the settings of the TV, the System Audio Control function may not be available. For details, refer to the operating instructions of your TV.

### Audio Return Channel

If the system is connected to a TV's HDMI IN jack compatible with Audio Return Channel (ARC), you can listen to TV sound from the speakers of the system without connecting an optical digital cable.



#### Note

If the TV is not compatible with Audio Return Channel, the optical digital cable (supplied) needs to be connected (refer to the supplied Startup Guide).

### One-Touch Play Function

When you play content on a device (Blu-ray Disc player, "PlayStation4," etc.) connected to the TV, the system and TV are turned on automatically, the input of the system is switched to "TV" input, and sound is output from the speakers of the system.

#### Notes

- If the TV sound was output from the speakers of the TV the previous time you watched the TV, the system does not turn on and the sound and picture are output from the TV even if device content is played.
- Depending on the TV, the beginning part of content being played may not play correctly.

### Notes on HDMI Connections

- Use an HDMI-authorized cable.
- Use a Sony High Speed HDMI Cable with the Cable Type Logo.
- We do not recommend using an HDMI-DVI conversion cable.
- Audio signals (sampling frequency, bit length, etc.) transmitted from an HDMI jack may be suppressed by the connected device.

## Saving Power Consumption

To use the system while saving power consumption, change the following settings.

### Turn the System Off by Detecting the Using State

When you set the auto standby function to on, the system enters standby mode automatically when you do not operate the system for about 20 minutes and the system is not receiving an input signal.

**Press and hold CINEMA for 5 seconds to set the function to on or off.**

---

#### Auto standby on

The USB indicator flashes twice.  
The default setting for U.K./Ireland models is on.

---

#### Auto standby off

The USB indicator flashes once.  
The default setting for Australia/New Zealand models is off.

---

### Saving Power in Standby Mode

To save power consumption during the standby mode, set the BLUETOOTH standby mode (page 23) and Control for HDMI function (page 24) to off.  
The default settings for them are on.

## Troubleshooting

# Troubleshooting

If you experience any of the following difficulties while using the system, use this troubleshooting guide to help remedy the problem before requesting repairs. Should any problem persist, consult your nearest Sony dealer.

## Power

### The system does not power up.

- Check that the AC power cord (mains lead) is connected securely.
- Disconnect the AC power cord (mains lead) from the wall outlet (mains), and then reconnect after several minutes.

### The system is turned off automatically.

- The auto standby function is working. Set the auto standby function to off (page 25).

### The system does not turn on even when the TV is turned on.

- Set the Control for HDMI function to on (page 24). The TV must support the Control for HDMI function. For details, refer to the operating instructions of your TV.
- Check the speaker settings of the TV. The system power syncs with the speaker settings of the TV. For details, refer to the operating instructions of your TV.
- If the sound was output from the speakers of the TV the previous time, the system does not turn on even when the TV is turned on.

### The system turns off when the TV is turned off.

- Check the setting of the Control for HDMI function (page 24). When the Control for HDMI function is set to on, the system turns off automatically when you turn off the TV regardless of the input.

### The system does not turn off even when the TV is turned off.

- Check the setting of the Control for HDMI function (page 24). To turn the system off automatically regardless of the input when you turn off the TV, set the Control for HDMI function to on. The TV must support the Control for HDMI function. For details, refer to the operating instructions of your TV.

## Picture

### There is no picture or the picture is not output correctly.

- Select the appropriate input (page 16).
- When there is no picture while TV input is selected, select the TV channel that you want using the TV remote control.
- Disconnect the HDMI cable, then connect it again. Make sure that the cable is firmly inserted.

## Sound

### No TV sound is output from the system.

- Check the type and connection of the HDMI cable or optical digital cable that is connected to the system and the TV (refer to the supplied Startup Guide).
- Disconnect the cables that are connected between the TV and the system, then connect them firmly again. Disconnect the AC power cords

of the TV and the system from the AC outlets (mains), then connect them again.



- When the system and TV are connected with an HDMI cable, check the following.
  - The HDMI jack of the connected TV is labeled with “ARC.”
  - The Control for HDMI function of the TV is set to on.
  - On the system, the Control for HDMI function is set to on (page 24).
- If your TV is not compatible with Audio Return Channel, connect the optical digital cable (supplied) (refer to the supplied Startup Guide). If the TV is not compatible with Audio Return Channel, TV sound will not be output from the system even if the system is connected to the TV’s HDMI IN jack.
- If the sound of the device that is connected to the optical input jack of the TV is not output, try the following.
  - Connect the cable box or satellite box directly to the TV IN (OPTICAL) jack of the system.
- Press INPUT repeatedly to select the TV input (page 16).
- Increase the volume on the TV or cancel muting.
- Depending on the order in which you connect the TV and the system, the system may be muted. If this happens, turn on the TV first, then the system.
- Set the speakers setting of the TV (BRAVIA) to Audio System. Refer to the operating instructions of your TV regarding how to set the TV.
- Check the sound output of the TV. Refer to the operating instructions of the TV for the TV settings.
- The system supports the Dolby Digital and PCM audio formats (page 32). When you playback unsupported format, set the digital audio out setting of the TV (BRAVIA) to “PCM.”

For details, refer to the operating instructions of your TV.

### **The sound is output from both the system and the TV.**

- Mute the sound of the system or the TV.

### **No sound or only a very low-level sound of the device connected to the system is heard from the system.**

- Press  + and check the volume level (page 11).
- Press  or  + to cancel the muting function (page 11).
- Make sure the input source is selected correctly. You should try other input sources by pressing INPUT repeatedly (page 16).
- Check that all the cables and cords of the system and the connected device are firmly inserted.
- If the connected device supports the up-sampling feature, you need to turn it off.

### **The surround effect cannot be obtained.**

- Depending on the input signal and the sound mode setting, surround sound processing may not work effectively. The surround effect may be subtle, depending on the program or disc.
- To play multi channel audio, check the digital audio output setting on the device connected to the system. For details, refer to the operating instructions supplied with the connected device.

## **USB Device Connection**

### **The USB device is not recognized.**

- Try the following:
  - ① Turn the system off.
  - ② Remove and reconnect the USB device.
  - ③ Turn the system on.

- Make sure that the USB device is securely connected to the  (USB) port (page 17).
- Check to see if the USB device or a cable is damaged.
- Make sure that the USB device is on.
- If the USB device is connected via a USB hub, disconnect it and connect the USB device directly to the system.

## Mobile Device Connection

### BLUETOOTH connection cannot be completed.

- Make sure that the BLUETOOTH indicator on the Bar Speaker is lit (page 7).
- Make sure the BLUETOOTH device to be connected is turned on and the BLUETOOTH function is enabled.
- Bring the BLUETOOTH device close to the system.
- Pair this system and the BLUETOOTH device again. You may need to cancel the pairing with this system using your BLUETOOTH device first.
- If the BLUETOOTH function is set to off, set it to on (page 23).

### Pairing cannot be achieved.

- Bring the BLUETOOTH device close to the system.
- Make sure this system is not receiving interference from a wireless LAN device, other 2.4 GHz wireless devices, or a microwave oven. If a device that generates electromagnetic radiation is nearby, move the device away from this system.
- Pairing may not be possible if other BLUETOOTH devices are present around the system. In this case, turn off the other BLUETOOTH devices.

### Sound of the connected BLUETOOTH mobile device is not output from the system.

- Make sure that the BLUETOOTH indicator on the Bar Speaker is lit (page 7).
- Bring the BLUETOOTH device close to the system.
- If a device that generates electromagnetic radiation, such as a wireless LAN device, other BLUETOOTH devices, or a microwave oven is nearby, move the device away from this system.
- Move the USB 3.0 device and its cable away from this system.
- Remove any obstacle between this system and the BLUETOOTH device or move this system away from the obstacle.
- Reposition the connected BLUETOOTH device.
- Switch the wireless LAN frequency of any nearby wireless LAN router or PC to 5 GHz range.
- Increase the volume on the connected BLUETOOTH device.

### The sound is not in sync with the image.

- When you are watching movies, you may hear the sound with a slight delay from the image.

## Remote Control

### The remote control of this system does not function.

- Point the remote control at the remote control sensor on the Bar Speaker (page 7).
- Remove any obstacles in the path between the remote control and the system.
- Replace both batteries in the remote control with new ones, if they are weak.

- Make sure you are pressing the correct button on the remote control (page 11).

### **The TV remote control does not work.**

- Install the Bar Speaker so that it does not obstruct the remote control sensor of the TV.
- This problem might be solved by enabling the IR repeater function (page 15).

## **Others**

### **The Control for HDMI function does not work properly.**

- Check the connection with the system (refer to the supplied Startup Guide).
- Enable the Control for HDMI function on the TV. For details, refer to the operating instructions of your TV.
- Wait a while, and then try again. If you unplug the system, it will take a while before operations can be made. Wait for 15 seconds or longer, and then try again.
- Make sure the devices connected to the system support the Control for HDMI function.
- Enable the Control for HDMI function of the devices connected to the system. For details, refer to the operating instructions of your device.
- The type and number of devices that can be controlled by the Control for HDMI function is restricted by the HDMI CEC standard as follows:
  - Recording devices (Blu-ray Disc recorder, DVD recorder, etc.): up to 3 devices

- Playback devices (Blu-ray Disc player, DVD player, etc.): up to 3 devices
- Tuner-related devices: up to 4 devices
- Audio system (receiver/headphone): up to 1 device (used by this system)



### **All indicators on the Bar Speaker flash, the sound is muted, and buttons on the remote control or Bar Speaker other than (power) do not work.**

- The protection feature is activated. Press  (power) to turn the system off and disconnect the AC power cord (mains lead) and check the items below.
  - Make sure that the ventilations of the Bar Speaker are not covered and turn on the system after a while.
  - When the system is using the USB connection, remove the USB device and turn on the system. If the system operates properly, the current of the connected USB device is over the maximum output current of the system 500 mA, or the USB device may have an abnormality.

### **Sensors of the TV do not work properly.**

- The Bar Speaker may block some sensors (such as the brightness sensor), the remote control receiver of your TV or the emitter for 3D glasses (infrared transmission) of a 3D TV that supports the infrared 3D glass system, or wireless communication. Move the Bar Speaker away from the TV within a range that allows those parts to operate properly. For the locations of the sensors and remote control receiver, refer to the operating instructions supplied with the TV.

### The system does not work properly.

- The system may be in demo mode. To cancel demo mode, reset the system. Press and hold , +, and  on the Bar Speaker for more than 5 seconds (page 30).

### When you change to the TV input from the USB input by pressing INPUT, the message appears.



\* Please select the desired TV channels with the TV's remote control.

\* This screen is an example for English.

- Select the TV program by using the TV remote control.

## Resetting the System

If the system still does not operate properly, reset the system as follows.

- 1 Press and hold , +, and  on the Bar Speaker for more than 5 seconds.**

All indicators on the Bar Speaker flash 3 times, and the settings return to their initial status.

- 2 Disconnect the AC power cord (mains lead).**

- 3 Connect the AC power cord (mains lead), then press  to turn on the system.**

### Tip

The default settings are underlined on each feature description.

## Additional Information

# Specifications

### Amplifier section

#### POWER OUTPUT (rated)

Front woofer L + Front woofer R: 22 W + 22 W (at 8 ohms, 1 kHz, 1% THD)

Front tweeter L + Front tweeter R: 22 W + 22 W (at 8 ohms, 10 kHz, 1% THD)

#### POWER OUTPUT (reference)

Front L/R woofer blocks: 30 W (per channel at 8 ohms, 1 kHz)

Front L/R tweeter blocks: 30 W (per channel at 8 ohms, 10 kHz)

#### Audio Inputs

TV IN (OPTICAL)

USB

HDMI OUT (TV (ARC))

#### TV Display Output (USB display)

HDMI OUT (TV (ARC))

### USB section

↓ (USB) port:

Type A (For connecting USB memory)

### BLUETOOTH section

#### Communication system

BLUETOOTH Specification version 4.2

#### Output

BLUETOOTH Specification Power Class 1

#### Maximum communication range

Line of sight approx. 10 m<sup>1)</sup>

#### Frequency band

2.4 GHz band (2.4000 GHz - 2.4835 GHz)

#### Maximum output power

< 10.0 dBm

#### Modulation method

FHSS (Freq Hopping Spread Spectrum)

#### Compatible BLUETOOTH profiles<sup>2)</sup>

A2DP (Advanced Audio Distribution Profile)

AVRCP (Audio Video Remote Control Profile)

#### Supported Codec<sup>3)</sup>

SBC<sup>4)</sup>

#### Transmission range (A2DP)

20 Hz - 20,000 Hz (Sampling frequency 32 kHz, 44.1 kHz, 48 kHz)

- 1) The actual range will vary depending on factors such as obstacles between devices, magnetic fields around a microwave oven, static electricity, cordless phone use, reception sensitivity, the operating system, software applications, etc.
- 2) BLUETOOTH standard profiles indicate the purpose of BLUETOOTH communication between devices.
- 3) Codec: Audio signal compression and conversion format
- 4) Abbreviation for Subband Codec

### Front L/Front R speaker block section

#### Speaker system

2-way speaker system, Bass reflex

#### Speaker

Woofer: 48 mm × 90 mm cone type

Tweeter: 25 mm balanced dome type

### General

#### Power requirements

220 V - 240 V AC, 50 Hz/60 Hz

#### Power consumption

On: 30 W

Standby mode: 0.5 W or less (Power Saving mode)

(When Control for HDMI function and BLUETOOTH Standby mode are set to off)

Standby mode: 2 W or less

(When Control for HDMI function is set to on and/or BLUETOOTH Standby mode is set to on)

#### Dimensions\* (approx.) (w/h/d)

900 mm × 64 mm × 90 mm

\* Including projection portion

#### Mass (approx.)

2.4 kg

Design and specifications are subject to change without notice.

## Playable Types of Files (USB Input)

Codec	Extension
MP3 (MPEG-1 Audio Layer III)	.mp3
WMA9 Standard	.wma
LPCM (2ch)	.wav

### Notes

- Some files may not play or may play with no sound depending on the file format, the file encoding, or the recording condition.
- Some files edited on a PC may not play.
- The system does not play coded files such as DRM and Lossless.
- The system can recognize the following files or folders in USB devices:
  - up to 200 folders (including empty folder and root folder)
  - up to 150 tracks in one folder
  - up to folders in the 8th layer (including the root folder)
- Some USB devices may not work with this system.
- The system can recognize Mass Storage Class (MSC) devices.

## Supported Input Audio Formats (HDMI OUT (TV (ARC)) or TV IN (OPTICAL))

Audio formats supported by this system are as follows.

- Dolby Digital
- Linear PCM 2ch



---

## On BLUETOOTH Communication

- BLUETOOTH devices should be used within approximately 10 meters (33 feet) (unobstructed distance) of each other. The effective communication range may become shorter under the following conditions.
  - When a person, metal object, wall or other obstruction is between the devices with a BLUETOOTH connection
  - Locations where a wireless LAN is installed
  - Around microwave ovens that are in use
  - Locations where other electromagnetic waves occur
- BLUETOOTH devices and wireless LAN (IEEE 802.11b/g/n) use the same frequency band (2.4 GHz). When using your BLUETOOTH device near a device with wireless LAN capability, electromagnetic interference may occur. This could result in lower data transfer rates, noise, or inability to connect. If this happens, try the following remedies:
  - Use this system at least 10 meters (33 feet) away from the wireless LAN device.
  - Turn off the power to the wireless LAN device when using your BLUETOOTH device within 10 meters (33 feet).
  - Install this system and BLUETOOTH device as close to each other as possible.
- The radio waves broadcast by this system may interfere with the operation of some medical devices. Since this interference may result in malfunction, always turn off the power on this system and BLUETOOTH device in the following locations:

- In hospitals, on trains, in airplanes, at gas stations, and any place where flammable gasses may be present
- Near automatic doors or fire alarms
- This system supports security functions that comply with the BLUETOOTH specification to ensure secure connection during communication using BLUETOOTH technology. However, this security may be insufficient depending on the setting contents and other factors, so always be careful when performing communication using BLUETOOTH technology.
- Sony cannot be held liable in any way for damages or other loss resulting from information leaks during communication using BLUETOOTH technology.
- BLUETOOTH communication is not necessarily guaranteed with all BLUETOOTH devices that have the same profile as this system.
- BLUETOOTH devices connected with this system must comply with the BLUETOOTH specification prescribed by the Bluetooth SIG, Inc., and must be certified to comply. However, even when a device complies with the BLUETOOTH specification, there may be cases where the characteristics or specifications of the BLUETOOTH device make it impossible to connect, or may result in different control methods, display or operation.
- Noise may occur or the audio may cut off depending on the BLUETOOTH device connected with this system, the communications environment, or surrounding conditions.

If you have any questions or problems concerning your system, please consult your nearest Sony dealer.

# Precautions

## On safety

- Should any solid object or liquid fall into the system, unplug the system and have it checked by qualified personnel before operating it any further.
- Do not climb on the Bar Speaker, as you may fall down and injure yourself, or system damage may result.

## On power sources

- Before operating the system, check that the operating voltage is identical to your local power supply. The operating voltage is indicated on the nameplate on the bottom of the Bar Speaker.
- If you are not going to use the system for a long time, be sure to disconnect the system from the wall outlet (mains). To disconnect the AC power cord (mains lead), grasp the plug itself; never pull the cord.
- One blade of the plug is wider than the other for the purpose of safety and will fit into the wall outlet (mains) only one way. If you are unable to insert the plug fully into the outlet, contact your dealer.
- AC power cord (mains lead) must be changed only at a qualified service shop.

## On heat buildup

Although the system heats up during operation, this is not a malfunction. If you continuously use this system at high volume, the system temperature at the rear and bottom rises considerably. To avoid burning yourself, do not touch the system.

## On placement

- Place the system in a location with adequate ventilation to prevent heat buildup and prolong the life of the system.
- Do not place the system near heat sources or in a place subject to direct

sunlight, excessive dust, or mechanical shock.

- Do not place anything on the top of the Bar Speaker.
- If the system is being used in combination with a TV, VCR, or tape deck, noise may result and picture quality may suffer. In such a case, place the system away from the TV, VCR, or tape deck.
- Use caution when placing the system on a surface that has been specially treated (with wax, oil, polish, etc.), as staining or discoloration of the surface may result.
- Take care to avoid any possible injury from the corners of the Bar Speaker.

## On operation

Before connecting other equipment, be sure to turn off and unplug the system.

## If you encounter color irregularity on a nearby TV screen

Color irregularities may be observed on certain types of TV.

- If color irregularity is observed...  
Turn off the TV, then turn it on again after 15 to 30 minutes.
- If color irregularity is observed again...  
Place the system further away from the TV.

## On cleaning

Clean the system with a soft, dry cloth. Do not use any type of abrasive pad, scouring powder, or solvent such as alcohol or benzene.

If you have any question or problem concerning your system, please consult your nearest Sony dealer.

## Copyrights and Trademarks

This system incorporates Dolby\* Digital.

\* Manufactured under license from Dolby Laboratories.

Dolby, Dolby Audio and the double-D symbol are trademarks of Dolby Laboratories.

This system incorporates High-Definition Multimedia Interface (HDMI™) technology. The terms HDMI and HDMI High-Definition Multimedia Interface, and the HDMI Logo are trademarks or registered trademarks of HDMI Licensing Administrator, Inc. in the United States and other countries.

The BLUETOOTH® word mark and logos are registered trademarks owned by Bluetooth SIG, Inc. and any use of such marks by Sony Corporation is under license. Other trademarks and trade names are those of their respective owners.

“BRAVIA” logo is a trademark of Sony Corporation.

MPEG Layer-3 audio coding technology and patents licensed from Fraunhofer IIS and Thomson.

Windows Media is either a registered trademark or trademark of Microsoft Corporation in the United States and/or other countries.

This product is protected by certain intellectual property rights of Microsoft Corporation. Use or distribution of such technology outside of this product is prohibited without a license from Microsoft or an authorized Microsoft subsidiary.

All other trademarks are trademarks of their respective owners.

# HDMI

<http://www.sony.net/>



\* 4 7 2 7 4 1 0 2 3 \* (1)

©2018 Sony Corporation Printed in China

4-727-410-23(1)